



Characteristics



- High performance industrial air curtains for vertical or horizontal installations for large industrial doors. Available in 1.5, 2.0, 2.5, 3.0 and 3.5 meters length. Easy dockable modules to reach large dimensions.
- Heavy self-supporting casing construction made of galvanized steel plate, finished in structural epoxy-polyester painting white colour RAL9016 as standard. Other colours are available on request.
- Double outlet with Coanda effect to achieve larger and efficient air jet. Anodized aluminium outlet vanes, airfoil shaped, adjustable from 0 to 15° each side.
- High efficiency and low noise axial fans, driven with external rotor motor single phase 230V. Optionally three phase 400V. Maintenance free.
- “P” type with water heated coil. “A” type without heating, air only. “E” type with electrical shielded elements with contactors included.
- Regulation not included. Optional: Basic regulation with Plug&Play control panel provided with 5-speed selection, 10m RJ45 cable and remote control. Advanced regulation with Clever (automatic, intelligent, energy saving, Modbus RTU for BMS...).

Specifications

AIR ONLY

Model	Airflow m³/h	Power Fans 230V-50Hz kW	Current Fans 230V-50Hz A	Noise Level (5m) dB(A)	Weight kg
MXW 1500 A	7000	0,68	2,96	60	79
MXW 2000 A	10500	1,02	4,44	61	103
MXW 2500 A	14000	1,36	5,92	62	126
MXW 3000 A	17500	1,70	7,40	63	150
MXW 3500 A	20800	2,04	8,88	64	173

ELECTRICAL HEATED

Model	Airflow m³/h	Electrical Heating Capacity 400Vx3-50Hz kW	Power Fans 230V-50Hz kW	Current Fans 230V-50Hz A	Noise Level (5m) dB(A)	Weight kg
MXW 1500 E	7000	15/22,5/37,5 (*)	0,68	2,96	62	96
MXW 2000 E	10500	20/30/50 (*)	1,02	4,44	63	133
MXW 2500 E	14000	30/40/70 (**)	1,36	5,92	64	167
MXW 3000 E	17500	30/50/80 (**)	1,70	7,40	65	201
MXW 3500 E	20800	30/60/90 (**)	2,04	8,88	66	231

(*) 2 separated power supplies.

(**) 3 separated power supplies.

WATER HEATED

Model	Airflow m³/h	Heating Capacity 80/60°C kW	P86		P64			Power Fans 230V-50Hz kW	Current Fans 230V-50Hz A	Noise Level (5m) dB(A)	Weight kg
			Water Drop Pressure 80/60°C Pa	Water Connections 80/60°C	Heating Capacity 60/40°C kW	Water Drop Pressure 60/40°C Pa	Water Connections 60/40°C				
MXW 1500 P	6800	41,39	12040	2x1¼"	34,09	12620	2x1¼"	0,68	2,96	59	95
MXW 2000 P	10200	61,25	16920	2x1¼"	50,16	13660	2x1¼"	1,02	4,44	60	126
MXW 2500 P	13600	80,05	13940	2x1¼"	66,19	14600	2x1¼"	1,36	5,92	61	158
MXW 3000 P	17000	99,88	16260	2x1¼"	82,22	14560	2x1¼"	1,70	7,40	62	189
MXW 3500 P	20300	118,28	14080	2x1¼"	97,92	14910	2x1¼"	2,04	8,88	63	221

Water heated: P86 2 rows coil, P64 3 rows coil.

Dimensions

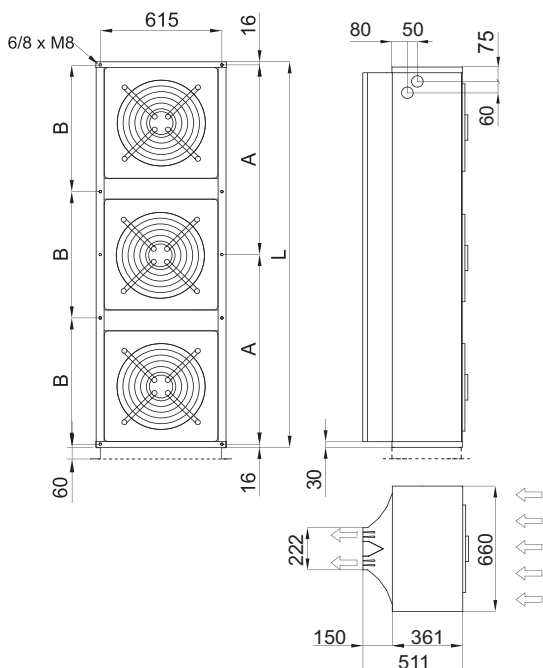

	L	A	B
MXW 1500	1500	734	-
MXW 2000	2000	984	-
MXW 2500	2500	1234	-
MXW 3000	3040	-	1002,5
MXW 3500	3620	-	1196